

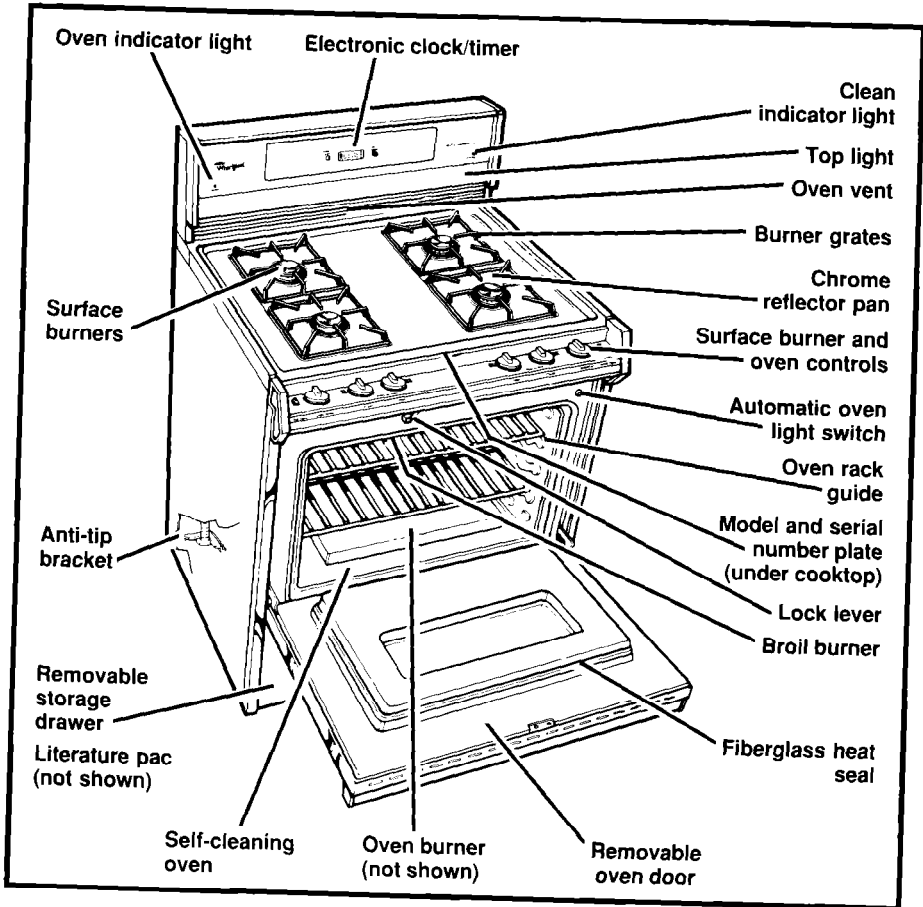

# Use & Care Guide



**SELF-CLEANING GAS RANGE**  
**SF376PEW (Shown)**  
**SF375PEW**

# Contents

	Page
<b>Important Safety Instructions</b> .....	3
<b>Using Your Range</b> .....	6
Using the surface burners .....	6
Setting the clock .....	7
Using the Minute Timer .....	8
Using the oven controls .....	9
Baking .....	9
Adjusting the oven temperature control .....	10
Broiling .....	11
Using the Cook Timer .....	13
The oven vent .....	15
The storage drawer .....	15
<b>Caring For Your Range</b> .....	17
Control panel and knobs .....	17
Surface burner grates and reflector pans .....	18
Surface burners .....	19
Removable cooktop .....	20
Removable oven door .....	21
Using the Self-Cleaning cycle .....	22
Cleaning tips .....	26
Using and replacing the light bulbs .....	27
<b>If You Need Service Or Assistance</b> .....	29
<b>Whirlpool Range Warranty</b> .....	32

©1990 Whirlpool Corporation

Remove the Consumer Buy Guide label. It will be easier to remove before the range is used. To remove any remaining glue:

- Rub briskly with thumb to make a ball, then remove.  
or
- Soak area with liquid hand dishwashing detergent before removing glue as described above.

Do not use sharp instruments, rubbing alcohol, flammable fluids or abrasive cleaners. These can damage the finish. See "Important Safety Instructions" on page 3.

**Thank you for buying a Whirlpool appliance. Please complete and mail the Owner Registration Card provided with this product.** Then complete the form below. Have this information ready if you need service or call with a question.

- Copy model and serial numbers from plate (located as shown) and purchase date from sales slip.
- Keep this book, the Cooking Guide and sales slip together in the Literature Pac.

---

Model Number

---

Serial Number

---

Purchase Date

---

Service Company Phone Number

## You are responsible for:

- Installing and leveling the range on a floor strong enough to support its weight, and where it is protected from the elements. (See the Installation Instructions.)
- Making sure the range is not used by anyone unable to operate it properly.
- Properly maintaining the range.
- Using the range only for jobs expected of a home range.
- Making sure the range is secured by properly installed anti-tip bracket(s), with rear leveling leg(s) positioned under bracket(s).

# Important Safety Instructions

Gas ranges have been thoroughly tested for safe and efficient operation. However, as with any appliance, there are specific installation and safety precautions which must be followed to ensure safe and satisfactory operation.

## **⚠ WARNING**

To reduce the risk of fire, electrical shock, injury to persons, or damage when using the range, follow basic precautions, including the following:

### • FOR YOUR SAFETY •

**DO NOT STORE OR USE GASOLINE OR OTHER FLAMMABLE VAPORS AND LIQUIDS IN THE VICINITY OF THIS OR ANY OTHER APPLIANCE. THE FUMES CAN CREATE A FIRE HAZARD OR EXPLOSION.**

### • FOR YOUR SAFETY •

**IF YOU SMELL GAS:**

- 1. OPEN WINDOWS.**
- 2. DON'T TOUCH ELECTRICAL SWITCHES.**
- 3. EXTINGUISH ANY OPEN FLAMES.**
- 4. IMMEDIATELY CALL YOUR GAS SUPPLIER.**

**IMPROPER INSTALLATION, ADJUSTMENT, ALTERATION, SERVICE OR MAINTENANCE CAN CAUSE INJURY OR PROPERTY DAMAGE. REFER TO THIS MANUAL. FOR ASSISTANCE OR ADDITIONAL INFORMATION CONSULT A QUALIFIED INSTALLER, SERVICE AGENCY, MANUFACTURER (DEALER) OR THE GAS SUPPLIER.**

### **- IMPORTANT -**

**TO THE INSTALLER: PLEASE LEAVE THIS INSTRUCTION BOOK WITH THE UNIT.**

**TO THE CONSUMER: PLEASE READ AND KEEP THIS BOOK FOR FUTURE REFERENCE.**

## Important Safety Instructions Continued

- Install or locate the range only in accordance with the provided Installation Instructions. It is recommended that the range be installed by a qualified installer. The range must be properly connected to the proper gas supply and checked for leaks. The range must also be properly connected to electrical supply and grounded.

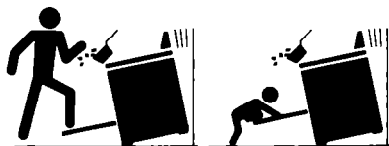

- To reduce the risk of tipping of the appliance, the appliance must be secured by properly installed anti-tip bracket(s). To check if the bracket(s) is installed properly, remove the storage drawer (see page 15) and verify that the anti-tip bracket(s) is engaged.
- Gas fuels and combustion can result in potential exposure to chemicals known to cause cancer or reproductive harm. For example, benzene is a chemical which is a part of the gas supplied to the range. It is consumed in the flame during combustion. However, exposure to a small amount of benzene is possible if a gas leak occurs. Formaldehyde, carbon monoxide and soot are by-products of incomplete combustion. Properly adjusted burners with a bluish rather than a yellow flame will minimize incomplete combustion.
- Do not operate the range if it is not working properly, or if it has been damaged.
- Do not use the range for warming or heating the room. Persons could be burned or injured, or a fire could start.
- Use the range only for its intended use as described in this manual.
- Do not wear loose or hanging garments when using the range. They could ignite if they touch a hot surface burner and you could be burned.
- Do not touch surface burners, areas near burners or interior surfaces of oven. Areas near surface burners and interior surfaces of an oven become hot enough to cause burns. During use, do not touch, or let clothing or other flammable materials contact surface burners, areas near surface burners or interior surfaces of oven. Other surfaces of the range may become hot enough to cause burns; such as, the oven vent opening, the surface near the vent opening, the cooktop, the oven door and window.
- Make sure the utensils you use are large enough to contain food and avoid boil-overs and spill-overs. Heavy splattering or spill-overs left on a range can ignite and burn you. Pan size is especially important in deep fat frying.
- Turn pan handles inward, but not over other surface burners. This will help reduce the chance of burns, igniting of flammable materials, and spills due to bumping of the pan.
- Use only dry potholders. Moist or damp potholders on surface burners may result in burns from steam. Do not let potholder touch surface burners. Do not use a towel or bulky cloth for a potholder. They could catch on fire.
- Check to be sure glass cooking utensils are safe for use on the range. Only certain types of glass, glass-ceramic, ceramic, earthenware or other glazed utensils are suitable for ranges without breaking due to the sudden change in temperature.

- Do not use decorative covers or trivets over the surface burners.
- Do not heat unopened containers. They could explode. The hot contents could cause burns and container particles could cause injury.
- Grease is flammable and should be handled carefully. Let fat cool before attempting to handle it. Do not allow grease to collect around cooktop or in vents. Wipe spill-overs immediately.
- Do not use water on grease fires. Never pick up a flaming pan. Smother flaming pan on range by covering with a well-fitted lid, cookie sheet or flat tray. Flaming grease outside of pan can be extinguished with baking soda or, if available, a multipurpose dry chemical or foam-type extinguisher.
- Never leave surface burners unattended at high heat settings. A boil-over could result and cause smoking and greasy spill-overs that may ignite.
- Make sure surface burners are off when you are finished, and when you aren't watching.
- Use care when opening oven door. Let hot air or steam escape before removing or replacing food.
- Always position oven racks in desired location while oven is cool.
- Do not store flammable materials on or near the range. They could explode or burn.
- Do not store things children might want above the range. Children could be burned or injured while climbing on it.
- Do not leave children alone or unattended in area where the range is in use. They should never be allowed to sit or stand on any part of the range. They could be burned or injured.
- Never use a match or other flame to look for a gas leak. Explosion and injury could result.
- Know where your main gas shut off valve is located.
- Keep range vents unobstructed.
- Clean your range regularly. See care and cleaning instructions in this manual.
- Be sure all range parts are cool before cleaning.
- Do not clean door heat seal. It is essential for a good seal. Care should be taken not to rub, damage, or move the seal. Clean only parts recommended in this Use and Care Guide.
- Do not use oven cleaners. No commercial oven cleaner or oven liner protective coating of any kind should be used in or around any part of the oven.
- Before self-cleaning the oven, remove broiler pan, broiler grid, oven racks and other utensils. Do not use your oven to clean miscellaneous parts.
- Do not repair or replace any part of the range unless specifically recommended in this manual. All other servicing should be referred to a qualified technician.
- Disconnect the electrical supply before servicing the range.

**- SAVE THESE INSTRUCTIONS -**

# Using Your Range

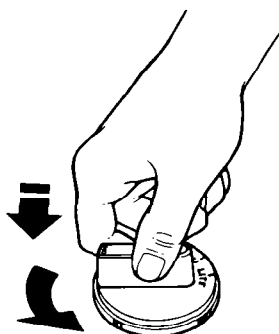

Surface burner marker 

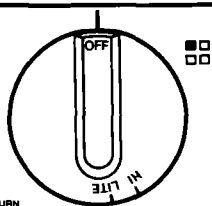

## Using the surface burners

**Control knobs must be pushed in**, then turned to the LITE position. The clicking sound is the ignition sparking.

To stop the clicking sound after the burner lights, turn the control knob back to a desired setting. The control knob has markings for HI, MED and LOW, however, it can be set anywhere between HI and OFF.

### Surface burner markers

The solid dot in the surface burner marker shows which surface burner is turned on by that knob.

**Until you get used to the settings, use the following as a guide.** For best results, start cooking at the high settings; then turn the control knob down to continue cooking.

**Use LITE** to light the burner. After the burner lights, turn control back to a desired setting to stop the clicking of the ignition.

**Use HI** to start foods cooking; to bring liquids to a boil.

**Use MED** to continue cooking or to fry chicken or pancakes; for gravy, puddings and icing; to cook large amounts of vegetables.

**Use LOW** to keep food warm until ready to serve.

**NOTE:** Do not cook with the control in the LITE position.

**In case of a prolonged power failure:**

Surface burners can be manually lighted. Hold a lighted match near a burner and turn the control to the LITE position. After the burner lights, turn the control to the desired setting.

**⚠ WARNING**

**Burn, Fire and Explosion Hazard**

- **Burner flame should not extend beyond the edge of the cooking utensil. The flame can burn you and cause poor cooking results.**
- **Be sure all control knobs are turned to OFF when you are not cooking. Someone could be burned or a fire could start if a burner is accidentally left ON.**
- **If the flame should go out while cooking, or if there is a strong gas odor, turn the burners OFF. Wait five minutes for the gas odor to disappear, before relighting burner. If gas odor is still present, see safety note on page 3. Failure to follow these precautions could result in explosion or fire.**
- **Do not attempt to light the oven burner during a power failure. Personal injury could result.**

**Setting the clock**

When the range is connected to power, the clock display will blink at "88:88" until the time-of-day is set.

Turn the Set Knob in either direction to set time-of-day. (Knob must be turned four or five clicks before time will advance.) The inverted triangle and the clock lights will light up on the display while the time is being set.

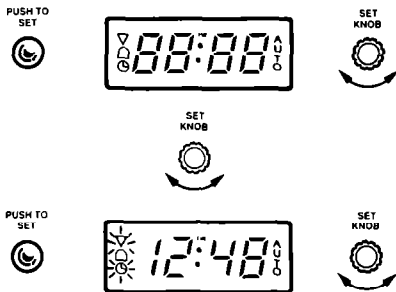

## Using the Minute Timer

The Minute Timer does not start or stop the oven. It works like a kitchen timer. It can be set in minutes and seconds up to 9 hours 50 minutes. You will hear a tone when the set time is up.

### To set the Minute Timer:

1. Push the Set button once. A tone will sound and the inverted triangle and bell lights will light up on the display. The display will show “:00”.
2. Turn the Set Knob clockwise to the desired setting, up to 9 hours 50 minutes.

**NOTE:** The knob must be turned within 15 seconds after the button is pushed.

The inverted triangle light goes off. The Minute Timer will count down the time and sound a tone at the end of the set time. At the end of the countdown “:00” will appear on the display, followed by time-of-day.

**NOTE:** Once the countdown passes the one-hour mark, the display will show minutes to the left of the colon. For example, 59 minutes will appear as “59:00”.

### To check time-of-day during a Minute Timer interval:

Push the Set button once. A tone will sound and the time-of-day will be displayed.

### To return to the Minute Timer display:

Push the Set button once. A tone will sound and the Minute Timer will reappear.

### To cancel the Minute Timer before the countdown is completed:

Turn the Set Knob to “0:00”. If no other time is set within three seconds, “88:88” will reappear on the display. Push the Set button to see time-of-day.

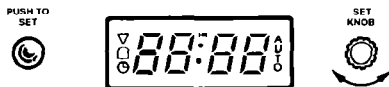
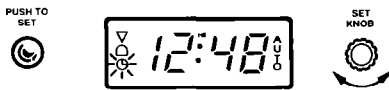
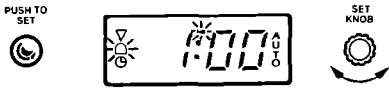
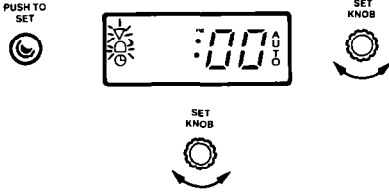

## Using the oven controls

### Baking

1. Position the rack(s) properly **before** turning on the oven. **To change rack position**, pull rack out to stop, raise front edge and lift out.

The rack(s) should be placed so the top of the food will be centered in the oven. Always leave at least 1 1/2 to 2 inches (4-5 cm) between the sides of the pan and the oven walls and other pans. For more information, see the Cooking Guide.

2. Set the Oven Selector on **BAKE**.
3. Set the Oven Temperature Control to the baking temperature you want. The oven burner will automatically light in 50-60 seconds.

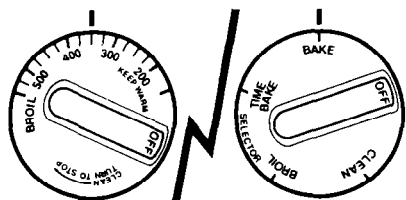
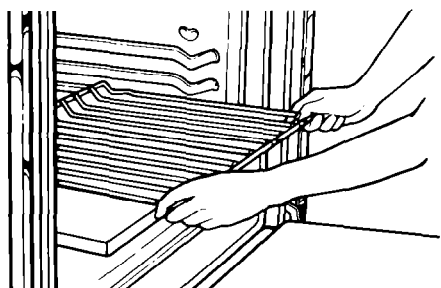

oven temp

selector

4. Preheat the oven for 10 minutes. Put food in the oven.

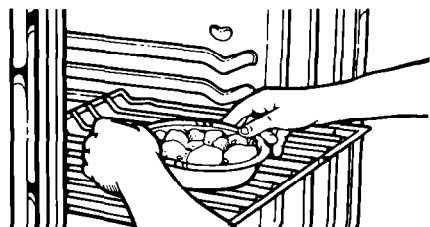

**NOTE:** Do not place food directly on the oven bottom.

5. During baking, the oven burner will turn on and off to maintain the temperature setting.

When baking is done, turn **both** the Oven Selector and the Oven Temperature Control to **OFF**.

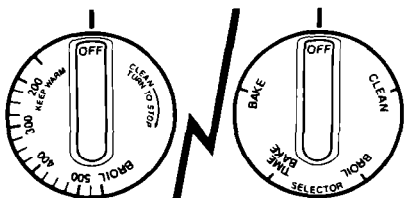

oven temp

selector

### Adjusting the oven temperature control

Does your oven seem hotter or colder than your old oven? The temperature of your old oven may have shifted gradually without you noticing the change. Your new oven is properly adjusted to provide accurate temperatures. But, when compared to your old oven, the new design may give you different results.

If, after using the oven for a period of time, you are not satisfied with the temperature settings, they can be adjusted by following these steps:

1. Pull the Oven Temperature Control Knob straight off.

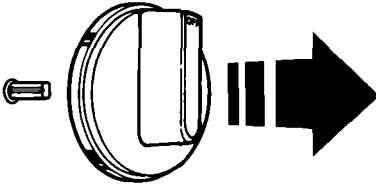

2. Loosen both locking screws. **Note the position of the indicator below the bottom screw.**

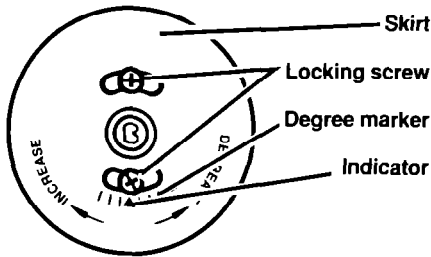

3. **To lower the temperature**, turn skirt counterclockwise to move indicator one degree marker to the right. Each degree marker equals about 10°F (5°C).
4. **To raise the temperature**, turn skirt clockwise to move indicator one degree marker to the left. Each degree marker equals about 10°F (5°C).

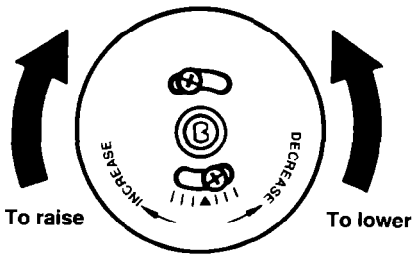

**Tighten the locking screws and replace the control knob.**

## Broiling

Refer to the Cooking Guide for additional broiling information. Because not all Cooking Guide information applies to this model, please read this section and the Cooking Guide carefully.

1. Position the rack **before** turning the oven on. Refer to broiling chart on next page for recommended rack positions and broiling times.
2. Preheat the broiler for 5 minutes before using. This heats the special ceramic coating on the burner reflector, which then radiates the heat rays into the food.
3. Put the broiler pan and food on the rack.
4. Completely close the oven door to assure proper broiling temperatures.

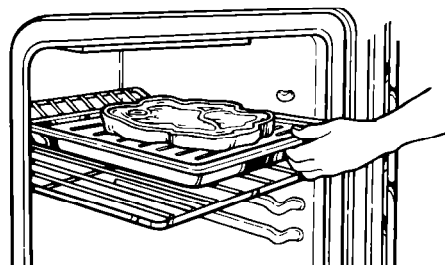
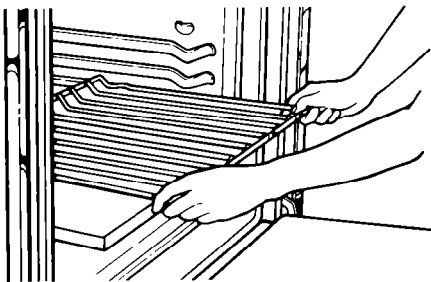

5. Set the Oven Selector and the Oven Temperature Control to BROIL. The broiler will automatically light in 50-60 seconds.

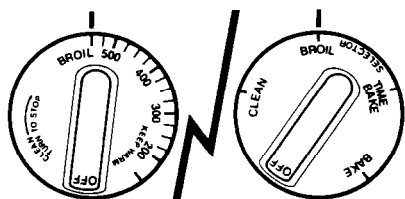

oven temp

selector

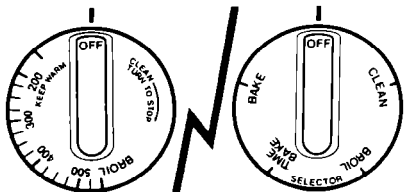

oven temp

selector

6. When broiling is done, turn **both** the Oven Selector and the Oven Temperature Control to OFF.

## Using Your Range Continued

### Broiling tips

- The effective useful cooking area of the broiler is reduced when you use the higher rack positions. In the second from the top rack position, the infra-red rays cover only about 85% of the broiler grid area.
- To sear meat, place broiler pan at one of the higher rack positions so that meat is very near the flame.
- Small steaks, hamburger patties, etc., may be broiled in the higher rack positions.
- To cook large steaks and other thick cuts of meat well done, move them to a lower rack position after searing. When broiling meat with a high fat content, it is recommended that the second rack position or a lower rack position be used.

### Broiling chart

The times and temperatures shown are provided as a general guide. Both may be varied to brown food or to achieve desired doneness.

			TIME IN MINUTES	
FOOD	SIZE	RACK POSITION	1 <sup>ST</sup> SIDE	2 <sup>ND</sup> SIDE
<b>Bacon</b>	Thin	2nd from top	4 - 6	
<b>Beef, ground</b>	1" thick	Middle	6	4
<b>Beef, steak</b>				
rare	3/4 - 1 1/4"	2nd from top	3	2
medium		2nd from top	5	3
well		Middle	7	5
rare	1 1/4 - 2"	2nd from top	6	4
medium		2nd from top	8	6
well		Middle	12	12
<b>Chicken</b>	2 lb. split Pieces	Middle Middle	25 - 30 15	10 - 15 12
<b>Fish</b>	1/2" fillet 1 1/2 lb. whole	2nd from top 2nd from top	7 - 9 (skin side down) 10	5
<b>Ham</b>	1/2" thick	2nd from top	6	4
<b>Lamb chops</b>	1/2" thick	2nd from top	6	4
<b>Pork chops</b>	1/2" thick	2nd from top	6	4

## Using the Cook Timer

The electronic Cook Timer allows you to begin cooking now and set the oven to turn itself off later.

### To set the Cook Timer:

1. Position the oven rack(s) properly, and place the food in the oven.
2. **Make sure the clock is set to the right time of day.** (See "Setting the clock" on page 7.)

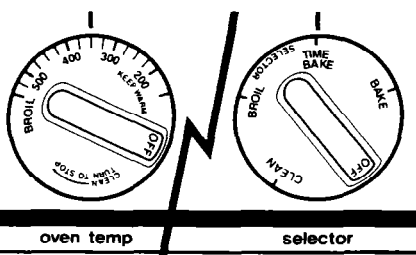

3. Set the Oven Selector on TIME BAKE.
4. Turn the Oven Temperature Control to the desired oven temperature.

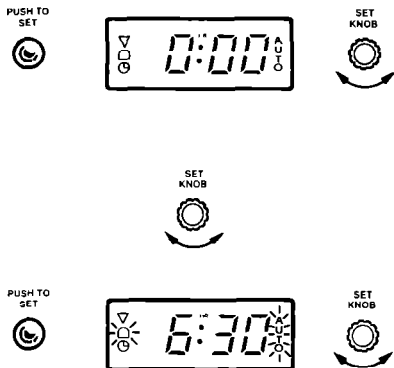

5. Push the Set button twice. A tone will sound with each push and the inverted triangle and bell lights will light up on the face of the clock along with the word "AUTO". The display shows ":00".

6. Turn the Set Knob to the desired cook time up to 9 hours 50 minutes.

**NOTE:** Knob must be turned within 15 seconds after button is pushed.

The oven will turn on within the next 30-40 seconds and will turn off automatically at the end of the set cook time.

## Using Your Range Continued

PUSH TO  
SET

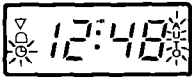

SET  
KNOB



### To check time-of-day during cooking:

Push the Set button once. A tone will sound and the time-of-day will be displayed.

PUSH TO  
SET



SET  
KNOB



### To return to the Cook Time display:

Push the Set button once. A tone will sound and the automatic cook time will reappear.

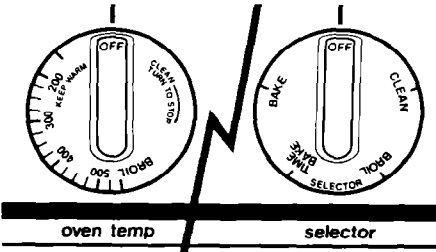

At the end of the set cook time a tone will sound and “:00” will appear on the display, followed by time-of-day. Turn both the Oven Selector and Oven Temperature Control to OFF.

## The oven vent

Hot air and moisture escape from the oven through a vent just under the cooktop light. The vent is needed for air circulation. **Do not block the vent.** Poor baking will result.

### **⚠ WARNING**

#### **Burn Hazard**

When the oven is ON, pans and pan handles left near the oven vent can become hot enough to burn the user and to melt plastics. Use potholders to move pans. Never store plastics, paper or other items that could melt or burn near the oven vent, or any of the surface burners.

## The storage drawer

The storage drawer is for storing pots and pans. The drawer can be removed to make it easier to clean under the range, and to check for installation of the anti-tip brackets. **Use care when handling the drawer.**

#### **Removing the storage drawer:**

1. Empty drawer of any pots and pans before removing drawer. Pull drawer straight out to the stop.
2. Push up black plastic lever on both sides of drawer.

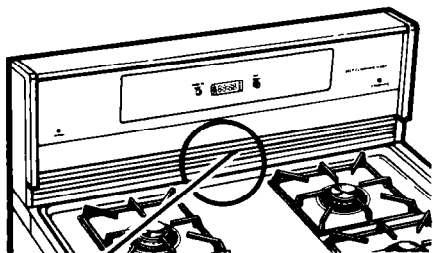

Oven vent

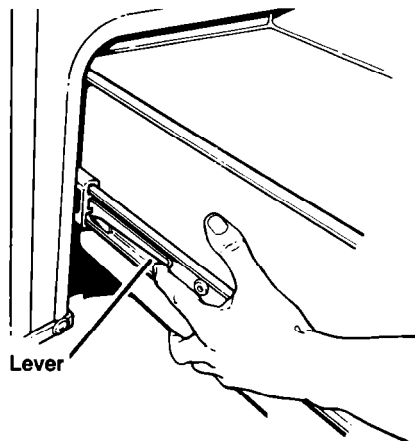

Lever

## Using Your Range Continued

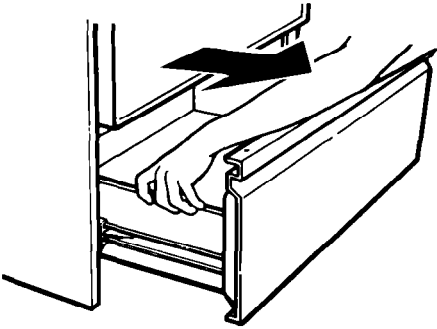

3. Pull drawer out a little farther until levers stay in "up" position. Pull drawer the rest of the way out.

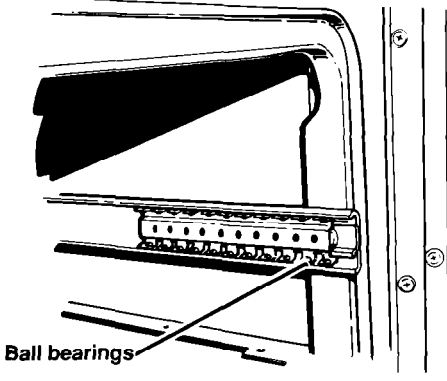

### Replacing the storage drawer:

1. Make sure ball bearings on oven slide rail are positioned toward the front of the opening.
2. Fit ends of drawer slide rails into the oven slide rails on both sides of the opening.
3. Slide drawer closed.

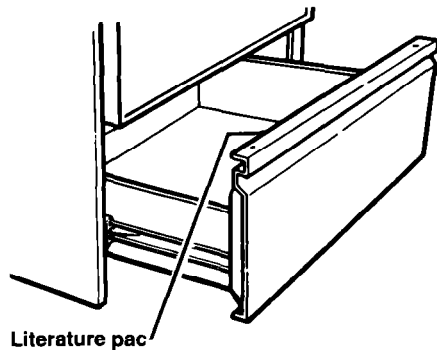

### Use and care guide storage

Store this booklet, along with your Cooking Guide and sales slip in the Literature Pac, inside the storage drawer.

### To verify that the anti-tip bracket(s) is engaged:

- Remove storage drawer.
- Look to see if the anti-tip bracket(s) is attached to floor with screws.
- Make sure rear leveling leg(s) is positioned under bracket(s).
- See "Important Safety Instructions" on page 4 and Installation Instructions for further details.

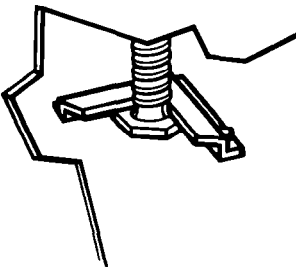

**NOTE:** The range will not tip during normal use. Tipping can occur if excessive force or weight is applied to open door without anti-tip bracket(s) properly secured.

# Caring For Your Range

## ⚠ WARNING

**Burn, Electrical Shock, Fire and Explosion Hazard**

- Make sure all controls are OFF and the range is cool before cleaning.
  - Do not use oven cleaners, bleach or rust removers.
  - Do not use gasoline or other flammable liquids or vapors to clean this or any other appliance.
  - Keep the appliance area clear and free from combustible materials, gasoline and other flammable vapors and liquids.
  - Do not obstruct the flow of combustion and ventilation air.
- Failure to follow these guidelines could result in burns, electrical shock, fire or explosion.

## Control panel and knobs

1. Turn control knobs to the OFF position.
2. Pull control knobs straight off.
3. Use warm soapy water or spray glass cleaner and a soft cloth to wipe the control panels. Rinse and wipe dry with a soft cloth.

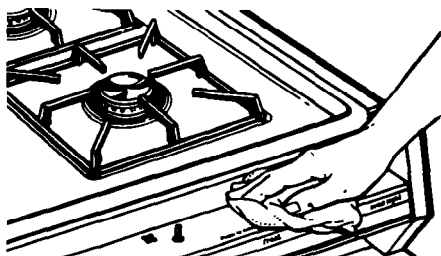
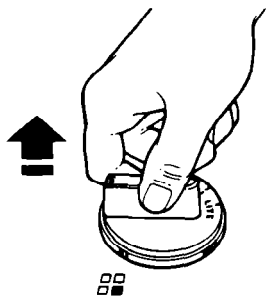

## Caring For Your Range Continued

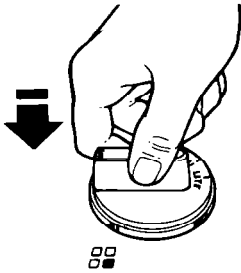
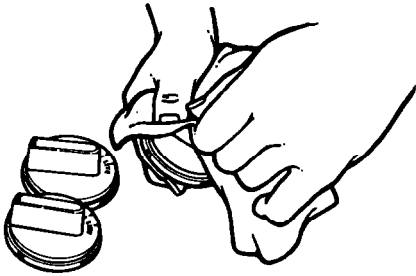

4. Wash control knobs in warm soapy water. Rinse well and dry with a soft cloth. Do not soak.

5. Replace control knobs by pushing them firmly into place.

**NOTE:** When cleaning, never use steel wool, abrasives, or commercial oven cleaners which may damage the finish. After cleaning, make sure all control knobs point to the OFF position.

## Surface burner grates and reflector pans

1. Make sure all surface burners are off and the surrounding parts are cool.

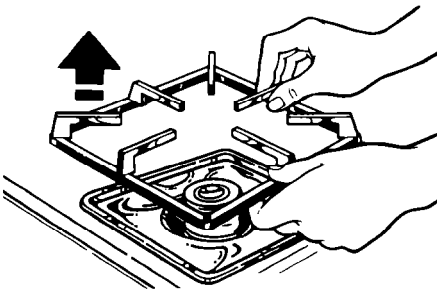
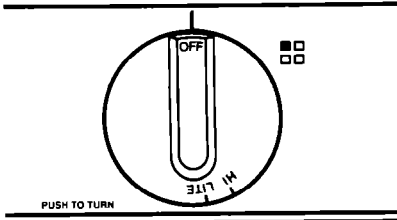

2. Lift off the burner grates and remove reflector pans.

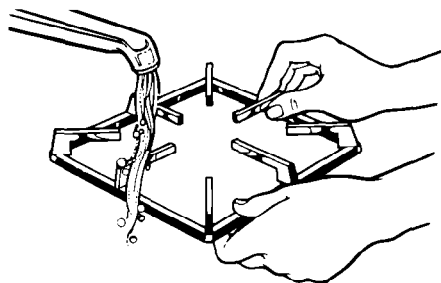

3. Wash the grates and reflector pans with warm soapy water or in a dishwasher. Use a non-abrasive plastic scouring pad for heavily-soiled areas. Rinse and dry well.

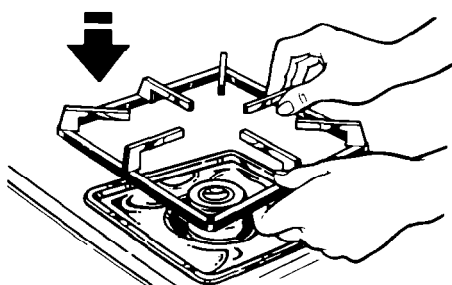

4. Replace reflector pans and burner grates.

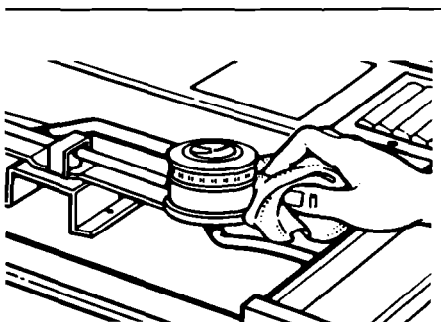

### Surface burners

To remove the cooktop, follow the instructions in "Removable cooktop" on page 20.

Wipe off surface burners with warm soapy water and a soft cloth after each use.

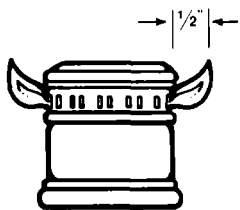

Typical surface burner flame

Occasionally check the burner flames for proper size and shape as shown. If flames lift off ports, are yellow, or are noisy when turned off, you may need to clean the burners (see "Cleaning tips" on page 26), or call a qualified technician for adjustment.

Replace cooktop.

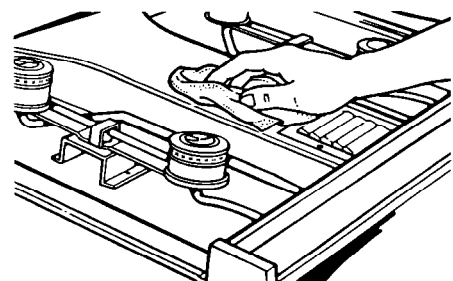
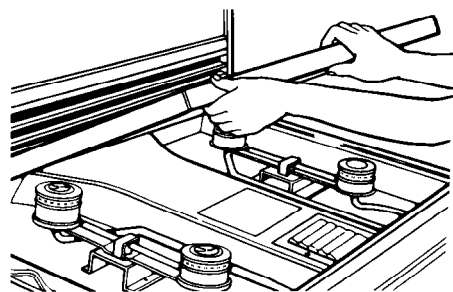
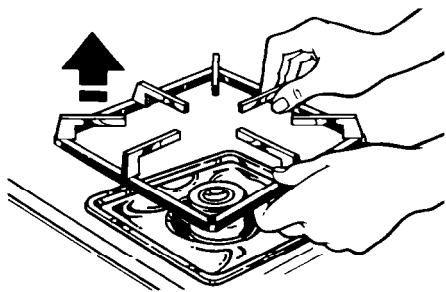

## Removable cooktop

1. Remove surface burner grates and reflector pans.
2. Lift front of cooktop enough to clear front of range. Grasp both sides of the cooktop, lift and pull forward to remove.
3. Wipe surface under the cooktop with warm soapy water. Use a soap-filled plastic scrubbing pad on heavily-soiled areas.
4. Replace cooktop by fitting back of cooktop into grooves in rear brackets. Lower cooktop. Replace reflector pans and surface burner grates.

### **⚠ WARNING**

#### **Personal Injury and Product Damage Hazard**

- Do not try to clean under the cooktop without removing it first. The cooktop could accidentally fall and injure you.
- Do not drop the cooktop. Damage can result to the porcelain and the cooktop frame.

## Removable oven door

### **⚠ WARNING**

**Burn and Electrical Shock Hazard**  
Make sure all controls are OFF and the oven is cool before removing oven door. Failure to do so can result in burns or electrical shock.

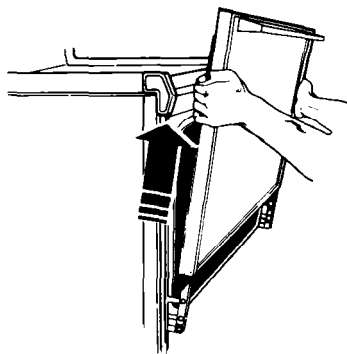

1. Open the door to the first stop position.
2. Hold the door at both sides and lift it **at the same angle it is in.**
3. **To replace,** fit the bottom corners of the door over the ends of the hinges.  
Push the door down evenly. The door will close only when it is on the hinges correctly.

## Using the Self-Cleaning cycle

The Self-Cleaning cycle uses **very high heat** to burn away soil. Before you start, make sure you understand exactly how to use the Self-Cleaning cycle safely.

### Before you start

**1. Clean the areas shown by hand.**

They do not get hot enough during the Self-Cleaning cycle for soil to burn away. Use hot water and detergent or a soapy steel wool pad on...

- The inside of the door. (The center area of the door does not need to be hand cleaned.)
- The frame around the oven.

**Do not** clean, move or bend the fiberglass seal. Poor cleaning and poor baking will result.

**2. Remove the broiler pan and any pots and pans you may have stored in the oven.**

**NOTE:** The broiler pan (without grid) can be cleaned in the oven only if most of the soil has been removed by hand-cleaning or a dishwasher. The chrome broiler grid will discolor if cleaned in the Self-Cleaning cycle.

**3. Wipe out any loose soil or grease.**

This will help reduce smoke during the Self-Cleaning cycle.

**4. If you want the oven racks to remain shiny, remove from the oven and clean them by hand.**

Otherwise, put oven racks on second and fourth guides (guides are counted from bottom to top). After racks are cleaned in the Self-Cleaning cycle, they become harder to slide. See page 26.

Turn on a vent hood or other kitchen vent during the Self-Cleaning cycle. This will help remove heat and odors that are normal during the cycle.

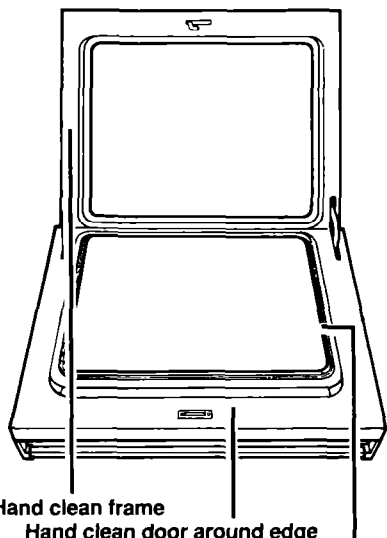

Hand clean frame

Hand clean door around edge

Do not hand clean seal

## ⚠ WARNING

### Personal Injury and Product Damage Hazard

- Do not touch the oven during the Self-Cleaning cycle. It could burn you.
- Do not use commercial oven cleaners in your oven. Cleaners may produce hazardous fumes or damage the porcelain finish.
- Do not force the Lock Lever, you could bend or break it. The lever is designed to stay locked until the oven is cool enough to safely open. Wait until it moves freely.
- Do not use foil or other liners in the oven. During the Self-Cleaning cycle foil can burn or melt and damage the oven surface.
- Do not block the vent during the Self-Cleaning cycle. Air must move freely for best cleaning results.
- Do not leave plastic utensils near the vent. They may melt.

### Setting the controls

1. Set the Oven Selector and Oven Temperature Control to CLEAN.

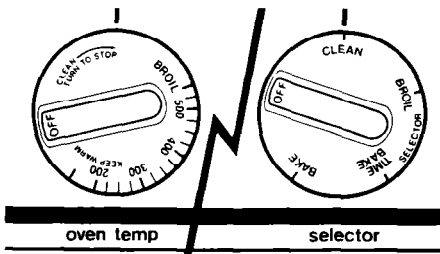

2. Push the Set button twice. A tone will sound with each push and the bell light will light up on the face of the clock along with the word "AUTO".

## Caring For Your Range Continued

PUSH TO  
SET

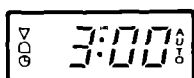

SET  
KNOB

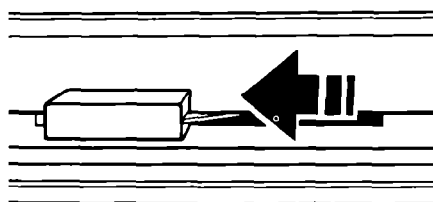
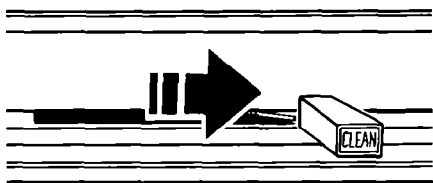

3. Turn the Set Knob **clockwise** 2-4 hours.

- Use 2 hours for light soil.
- Use 3 hours for moderate soil.
- Use 3-4 hours for heavy soil.

**NOTE:** Knob must be turned within 15 seconds after button is pushed.

4. Move the Lock Lever to the right - the Clean position. This will start the Self-Cleaning cycle. The Clean Indicator Light goes on. If the door is not all the way to the right, the cycle will not start.

The oven will turn on within the next 30-40 seconds and will turn off automatically at the end of the set clean time.

When the oven temperature exceeds normal baking temperatures, the door can't be opened and the Lock Lever must not be moved.

5. **After the Self-Cleaning cycle is completed and the oven temperature has dropped below 500°F (260°C),** the Clean Indicator Light goes off and the Lock Lever can be moved back to the COOK position. **Do not force it.** Wait until it moves easily. Turn the Oven Selector and Oven Temperature Control to OFF.

6. **After the oven is cool,** wipe off any residue or ash with a damp cloth. If needed, touch up spots with a soapy steel wool pad.

### Special tips

- Keep the kitchen well-ventilated during the Self-Cleaning cycle to help get rid of heat, odors and smoke.
- Clean the oven before it gets heavily soiled. Cleaning a very soiled oven takes longer and results in more smoke than usual.
- If the Self-Cleaning cycle doesn't get the oven as clean as you expected, the cycle may not have been set long enough or you may not have prepared the oven properly. Set the Self-Cleaning cycle longer the next time and hand clean areas noted on page 22.

**To stop the Self-Cleaning cycle at any time:**

1. Push the Set button twice and turn the Set Knob until "0:00" appears on the display.



2. Turn the Oven Selector and Oven Temperature Control to OFF. When the oven temperature drops below 500°F (260°C), move the Lock Lever to the COOK position. **Do not force it.** Wait until it moves easily.

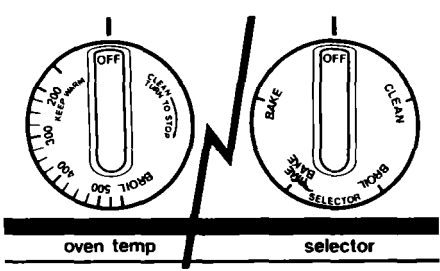

**How it works**

During the Self-Cleaning cycle, the oven gets much hotter than it does for baking or broiling...approximately 875°F (468°C). This heat breaks up grease and soil and burns it off.

This graph shows approximate temperatures and times during a Self-Cleaning cycle for 2 1/2 hours.

**Self-Cleaning cycle - 2 1/2 hour setting**  
(Approximate temperatures and times)

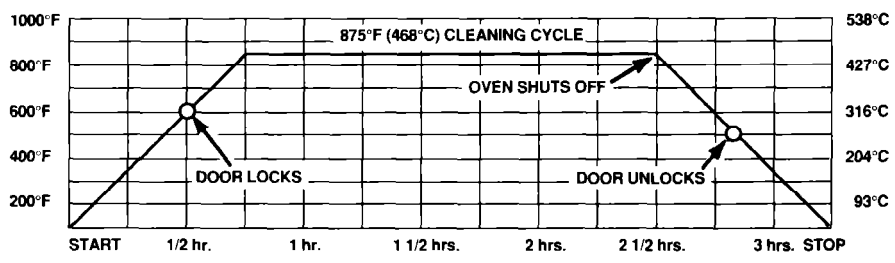

Notice that the heating stops when the 2 1/2 hour setting is up, but that it takes longer for the oven to cool down enough to unlock.

## Caring For Your Range Continued

### Cleaning tips

#### Control knobs

Clean with warm soapy water and a soft cloth.

- Wash, rinse and dry well.
- Do not soak.

#### Control panels

Clean with warm soapy water or spray glass cleaner and a soft cloth.

- Wash, rinse and dry well.
- Follow directions provided with the cleaner.

#### Exterior surfaces (other than cooktop)

Clean with warm soapy water and a soft cloth.

- Wipe off regularly when cooktop and oven are cool.

Use a non-abrasive plastic scrubbing pad for heavily-soiled areas.

- Do not use abrasive or harsh cleaners.

**NOTE:** Do not allow food containing acids (such as vinegar, tomato, lemon juice or milk) to remain on surface. Acids may remove the glossy finish. Be careful when cleaning around model and serial number plate; the numbers wipe off easily.

#### Surface burners

Clean with warm soapy water and a soft cloth.

- Remove cooktop (see page 20).
- Wipe off spills immediately after burner has cooled.

#### For cooked-on food:

- Remove burner from manifold with phillips screwdriver.
- Wash with warm soapy water and a non-abrasive plastic scrubbing pad.
- Rinse and dry well.
- If ports are clogged, clean with a straight pin. **Do not enlarge or distort port. Do not use a wooden toothpick.**
- Do not clean surface burner in dishwasher.

#### Surface burner grates and chrome reflector pans

Clean with warm soapy water and a non-abrasive plastic scrubbing pad.

- Wash, rinse and dry well.
- Dry completely.
- **Do not place in Self-Cleaning Oven.**

#### OR

Clean in a dishwasher.

#### Broiler pan and grid

Clean with warm soapy water or a soapy steel wool pad.

- Clean after each use.
- Wash, rinse and dry well.
- Do not clean in Self-Cleaning Oven. (See note on page 22.)

#### Oven racks

Use Self-Cleaning cycle.

- Leave in oven during Self-Cleaning cycle. **OR**

Clean with warm soapy water or soapy steel wool pads.

- Wash, rinse and dry. Use soapy steel wool pads for heavily-soiled areas.

**NOTE:** The oven racks will discolor and be harder to slide when left in the oven during the Self-Cleaning cycle. If you want them to stay shiny, remove from the oven and clean by hand. If racks are left in the oven during the Self-Cleaning cycle, apply a small amount of vegetable oil to the sides of the racks to make them easier to slide.

#### Oven door glass

Use spray glass cleaner or warm soapy water and a non-abrasive plastic scrubbing pad.

- Make sure oven is cool.
- Follow directions provided with the cleaner.
- Wash, rinse and dry well.

#### Self-Cleaning oven

For areas outside the Self-Cleaning area use warm soapy water or soapy steel wool pads.

- Follow directions starting on page 22, "Using the Self-Cleaning cycle."
- Do not use commercial oven cleaners.
- Do not use foil to line the bottom of your Self-Cleaning Oven.

## Using and replacing the light bulbs

### The cooktop light

The fluorescent light is on the bottom of the control panel. The Top Light Switch is located on the left side of the front control panel.

### **⚠ WARNING**

#### **Electrical Shock and Burn Hazard**

**Make sure power to the range has been disconnected at the main power supply and that all surface burners are OFF and cool. Failure to do so could result in electrical shock or burns.**

#### To replace the cooktop light:

1. Turn off all control knobs and unplug appliance or disconnect at the main power supply.
2. Pull Set Knob straight off.
3. Remove the four screws in the center of the oven vent grille. **Do not remove two top screws.**
4. **With both hands**, carefully remove oven vent grille and control panel glass.
5. Roll bottom of fluorescent tube towards you until both ends can be pulled out of the receptacles. Replace with a 20-watt cool-white fluorescent tube.
6. Insert control panel glass into top slot of the oven vent grille. Carefully replace glass and grille.

**NOTE:** The control panel glass must fit under the top lip of the upper control panel frame.

7. Replace the four screws in the oven vent grille.
8. Push Set Knob straight on.
9. Plug in appliance or reconnect at the main power supply.

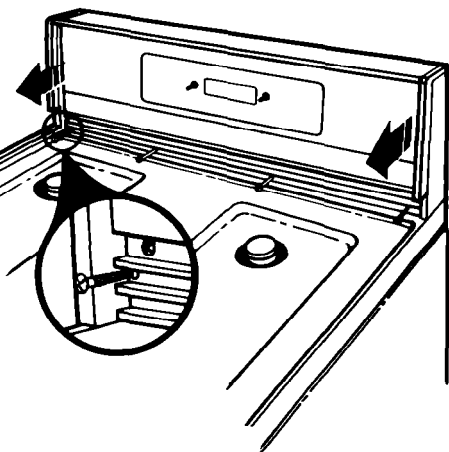

### The oven light

The Oven Light will come on when you open the oven door. To turn the light on when the oven door is closed, push the Oven Light Switch on the control panel. Push the switch again to turn off the light.

## **⚠ WARNING**

### **Electrical Shock and Personal Injury Hazard**

- **Make sure oven and light bulb are cool and power to the oven has been turned off before replacing the light bulb. Failure to do so could result in electrical shock or burns.**
- **The bulb cover must be in place when using the oven. The cover protects the bulb from breaking, and from high oven temperatures. Since bulb cover is made of glass, be careful not to drop it. Broken glass could cause injury.**

### To replace the oven light:

1. Unplug appliance or disconnect at the main power supply.
2. Remove the glass bulb cover in the back of the oven by screwing it out counterclockwise.
3. Remove the light bulb from its socket. Replace with a 40-watt appliance bulb.
4. Replace the bulb cover by screwing it in clockwise. Plug in appliance or reconnect at the main power supply.

**NOTE:** The oven light will not work during the Self-Cleaning cycle.

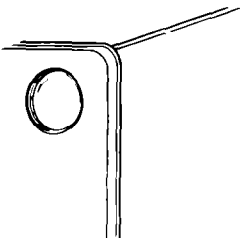
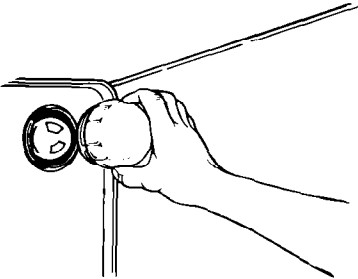

# If You Need Service Or Assistance...

## We suggest you follow these steps:

### 1. Before calling for assistance...

Performance problems often result from little things you can find and fix without tools of any kind.

### If nothing operates:

- Is the gas turned on?
- Is the power supply cord plugged into a live circuit with the proper voltage? (See Installation Instructions.)
- Have you checked your home's main fuses or circuit breaker box?
- Have instructions in this book been followed?
- Is the control knob set in the correct position?
- Is the flow of combustion and/or ventilation air to the unit obstructed?  
**Do not obstruct air flow to and around unit.**
- Recheck suspected defect.

### If the oven will not operate:

- Is the Oven Selector turned to BAKE or BROIL? If Oven Selector is turned to TIME BAKE, wait 30-40 seconds for oven to start.
- Is the Oven Temperature Control turned to a temperature setting?

### If burner fails to light:

- Is the range connected to electrical power?
- Have you checked your home's main fuses or circuit breaker box?
- Are burner ports clogged? See page 26.

### If burner flames are uneven:

- Are burner ports clogged? See page 26.

### If burner flames lift off ports, are yellow, or are noisy when turned off:

- The air/gas mixture may be incorrect. (Call for service.)

### If burner makes a popping noise when ON:

- Is the burner wet from washing? Let dry.

### If control knob(s) will not turn:

- Did you push in before trying to turn?

### If the Self-Cleaning cycle will not operate:

- Are the Oven Selector and the Oven Temperature Control set on CLEAN?
- Is the Set Knob set ahead to the time you want the Self-Cleaning cycle to stop?
- Is the Lock Lever all the way to the right?

### If cooking results aren't what you expected:

- Is the range level?
- Does the oven temperature seem too low or too high? See page 10.
- If needed, have you preheated the oven as the recipe calls for?
- Does the flame size fit the cooking utensil being used? (See the Cooking Guide.)
- If broiling, have you completely closed the oven door? Broiler provides best cooking results with the oven door closed.
- Are you following a tested recipe from a reliable source?
- Are you using pans recommended in the Cooking Guide?
- If baking, have you allowed 1 1/2 to 2 inches (4-5 cm) on all sides of the pans for air circulation?
- Are the pans the size called for in the recipe?
- Do the cooking utensils have smooth, flat bottoms and fit the surface burners being used?

See the Cooking Guide for more information on cooking problems and how to solve them.

## 2. If you need assistance\*...

**Call Whirlpool COOL-LINE® service assistance telephone number. Dial free from anywhere in the U.S.:**  
**1-800-253-1301**

and talk with one of our trained consultants. The consultant can instruct you in how to obtain satisfactory operation from your appliance or, if service is necessary, recommend a qualified service company in your area.

If you prefer, write to:

Mr. Donald Skinner  
Director of Consumer Relations  
Whirlpool Corporation  
2000 M-63  
Benton Harbor, MI 49022

Please include a daytime phone number in your correspondence.

## 3. If you need service\*...



Whirlpool has a nationwide network of authorized Whirlpool<sup>SM</sup>

service companies. Whirlpool service technicians are trained to fulfill the product warranty and provide after-warranty service, anywhere in the United States. To locate the authorized Whirlpool service company in your area, call our COOL-LINE® service assistance telephone number (see Step 2) or look in your telephone directory Yellow Pages under:

APPLIANCES - HOUSEHOLD - MAJOR - SERVICE & REPAIR      ELECTRICAL APPLIANCES - MAJOR - REPAIRING & PARTS

OR

WASHING MACHINES, DRYERS & IRONERS - SERVICING

WHIRLPOOL APPLIANCES  
AUTHORIZED WHIRLPOOL SERVICE

SERVICE COMPANIES  
XYZ SERVICE CO  
123 Maple ..... 999-9999

## 4. If you need FSP® replacement parts\*...

FSP is a registered trademark of Whirlpool Corporation for quality parts. Look for this symbol of quality whenever you need a replacement part for your Whirlpool appliance. FSP replacement parts will fit right and work right, because they are made to the same exacting specifications used to build every new Whirlpool appliance.

To locate FSP replacement parts in your area, refer to Step 3 above or call the Whirlpool COOL-LINE service assistance number in Step 2.

## 5. If you are not satisfied with how the problem was solved\*...

- Contact the Major Appliance Consumer Action Panel (MACAP). MACAP is a group of independent consumer experts that voices consumer views at the highest levels of the major appliance industry.
- Contact MACAP only when the dealer, authorized servicer or Whirlpool have failed to resolve your problem.

Major Appliance Consumer  
Action Panel  
20 North Wacker Drive  
Chicago, IL 60606

- MACAP will in turn inform us of your action.

\* When requesting assistance, please provide: model number, serial number, date of purchase, and a complete description of the problem. This information is needed in order to better respond to your request.



# WHIRLPOOL® Range Product Warranty

GR001

LENGTH OF WARRANTY	WHIRLPOOL WILL PAY FOR
<b>FULL ONE-YEAR WARRANTY</b> From Date of Purchase	FSP® replacement parts and repair labor to correct defects in materials or workmanship. Service must be provided by an authorized Whirlpool <sup>SM</sup> service company.
<b>WHIRLPOOL WILL NOT PAY FOR</b>	
<p><b>A.</b> Service calls to:</p> <ol style="list-style-type: none"> <li>1. Correct the installation of the range product.</li> <li>2. Instruct you how to use the range product.</li> <li>3. Replace house fuses or correct house wiring or plumbing.</li> <li>4. Replace owner accessible light bulbs.</li> </ol> <p><b>B.</b> Repairs when range product is used in other than normal, single-family household use.</p> <p><b>C.</b> Pick-up and delivery. This product is designed to be repaired in the home.</p> <p><b>D.</b> Damage to range product caused by accident, misuse, fire, flood, acts of God or use of products not approved by Whirlpool.</p>	

WHIRLPOOL CORPORATION SHALL NOT BE LIABLE FOR INCIDENTAL OR CONSEQUENTIAL DAMAGES. Some states do not allow the exclusion or limitation of incidental or consequential damages so this limitation or exclusion may not apply to you. This warranty gives you specific legal rights, and you may also have other rights which vary from state to state.

Outside the United States, a different warranty may apply. For details, please contact your franchised Whirlpool distributor or military exchange.

If you need service, first see the "Service and Assistance" section of this book. After checking "Service and Assistance," additional help can be found by calling our COOL-LINE® service assistance telephone number, **1-800-253-1301**, from anywhere in the U.S.

® Registered Trademark/SM Service Mark of Whirlpool Corporation